

ANSI - safety valve
Semi Nozzle (ANSI 150 - 300)

ARI-SAFE-SN ANSI (Semi-Nozzle)
ANSI-Safety Relief Valve

• Type-test approved acc. to ASME Code Section VIII-Division 1.

• UV-stamp NB-stamp

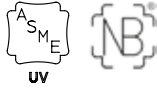

• Further approvals: see inside

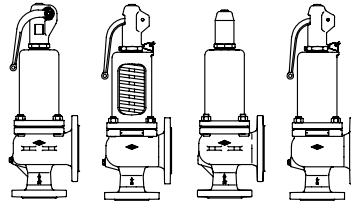

Fig. 901

902

911

912

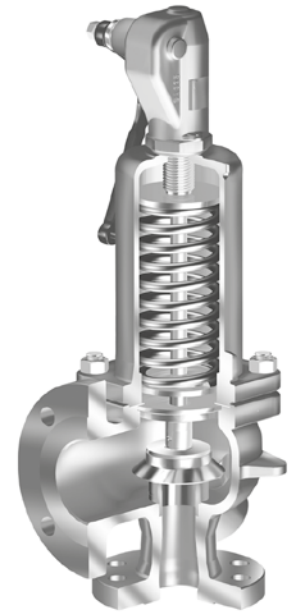

Fig. 900

Features:

- Direct loaded with spring
- Wear resistant seat/disc
- Precision disc alignment and guide
- Possible with soft seal disc
- Possible with EPDM bellows
- Possible with stainless steel bellows

ARI-SAFE-SN ANSI (Semi-Nozzle) ANSI-Safety Relief Valve

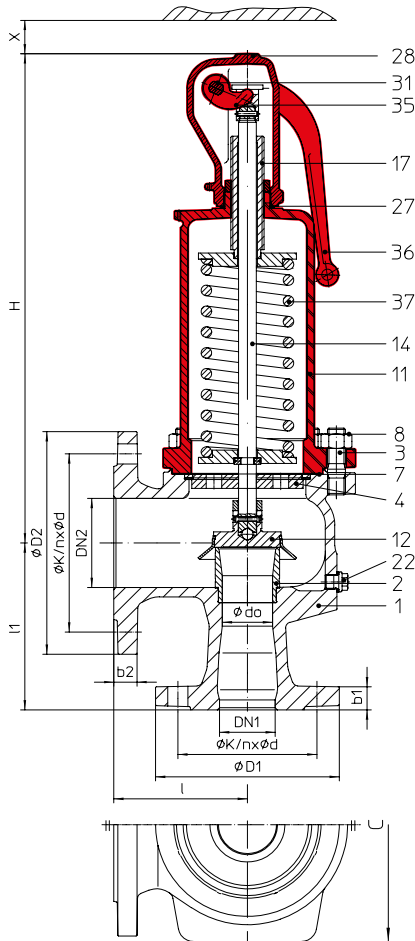

Fig. ...901
closed lifting device,
closed bonnet

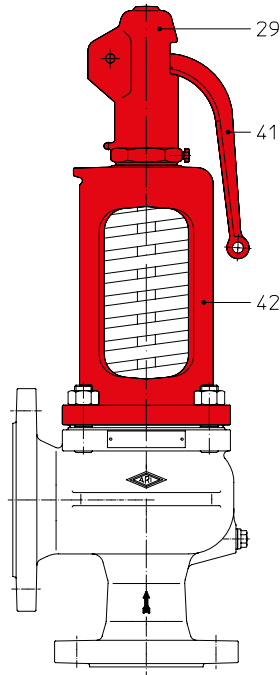

Fig. ...902
open lifting device,
open bonnet

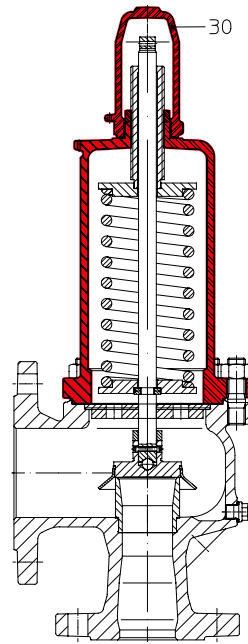

Fig. ...911
gastight cap,
closed bonnet

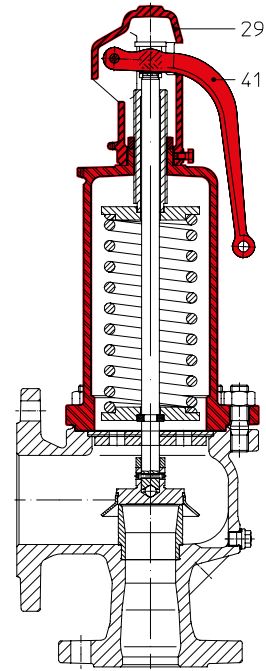

Fig. ...912
open lifting device,
closed bonnet

Figure	Nominal pressure	Material	Nominal diameter	Temperature range	Flange
32.901 / 902 / 911 / 912	ANSI150/150	SA216WCB	1" x 2" - 6" x 10"	-20°F to +800°F	ASME B16.5
35.901 / 902 / 911 / 912	ANSI300/150	SA216WCB	1" x 2" - 6" x 10"	-20°F to +800°F	ASME B16.5
52.901 / 911	ANSI150/150	SA351CF8M	1" x 2" - 6" x 10"	-75°F to 750°F	ASME B16.5
55.901 / 911	ANSI300/150	SA351CF8M	1" x 2" - 6" x 10"	-75°F to 750°F	ASME B16.5

Marking



UV-stamp **UV**



NB-stamp

National Board Cert.-No.

Steam / Gas: 08008, 08031

Liquid: 08019, 08020

Construction / Application

Safety valve, spring loaded, direct loaded; gases, vapours and liquids

Requirement

ASME Code Section VIII-Division 1.

Sizing

Calculation acc. to API 520 (ASME VIII)

Details required

Medium: Gas Mass flow (lb/hr), molar mass (kg/kmol), temperature (°F), set pressure (psig), back gauge pressure (psig)

Medium: Liquid Volume flow (gal/min), density, viscosity, temperature (°F), set pressure (psig), back gauge pressure (psig)

Order data:

ARI-SAFE-SN ANSI - safety valve, Figure ..., Nominal diameter .../..., ANSI ..., Material ..., Set pressure ... psig

	standard: without metal bellows	1" x 2" - 6" x 10" optional: with metal bellows (refer to page 8)
Superimposed back pressure	no backpressure allowed	on request
Built up back pressure	max. 10% from set pressure (gauge) (higher on request)	on request

Parts				
Pos.	Sp.p.	Description	Fig. 32.901/902/911/912; 35.901/902/911/912	Fig. 52.901/911; 55.901/911
1		Body	SA216WCB	SA351 CF8M
2		Seat	SA479 Gr.316 Ti	SA479 Gr.316 Ti
3		Studs	SA193 B7	SA193 B8
4	x	Spindle guide	NPS ≤ 2": SA276 Gr.420; NPS > 2": SA395 / SA276 Gr.440	NPS ≤ 2": SA479 Gr.316 Ti; NPS > 2": SA351 CF8M
7	x	Gasket	GRAPHIT/ SA240 Gr.316L (CrNi laminated with graphite)	
8		Hexagon nut	SA194 2H	SA194 8
11		Bonnet, closed	SA395	SA351 CF8M
12	x	Disc	SA276 Gr.440	SA479 Gr.316 Ti
14	x	Spindle	SA276 Gr.420	SA479 Gr.316 Ti
17		Adjusting screw	SA276 Gr.420	SA479 Gr.316 Ti
22		Plug screw (optional)	SA193-B7	SA193-B8
27	x	Sealing ring	CuFA	SA479 Gr.316 Ti
28		Cap, closed	SA395	SA351 CF8M
29		Cap, open	SA395	--
30		Cap, gastight	SA395	SA351 CF8M
31	x	Packing ring	GRAPHIT	
35		Lift fork	SA395	SA351 CF8M
36		Lever, closed	SA395	SA479 Gr.316 Ti
37	x	Spring	SA401 Gr.9254, SA29 Gr.6150	AISI 301
41		Lever, open	SA395	--
42		Bonnet, open	SA395	--
43		Bellows (optional)	EPDM 70 Shore A	
55		Stainless steel bellows unit (optional)	SA240 / SA479 Gr.316Ti	SA479 Gr.316 Ti
70		Balanced piston	SA240 Gr.316 Ti	SA479 Gr.316 Ti
	L Spare parts			

Certified coefficient of discharge K	UV-/NB-stamp							
	1"x2"	1 1/2"x2" 1 1/2"x2 1/2"	1 1/2"x3"	2"x3"	3"x4"	4"x6"	6"x8"	6"x10"
Steam / Gas	15 to < 30 psig: 0.769 / ≥ 30 psig: 0.817							
Liquid	≥ 15 psig: 0.615		≥ 15 psig: 0.545					

Seat tightness acc. API 527

Pressure-temperature-ratings			Intermediate values for max. permissible operational pressures can be determined by linear interpolation of the given temperature / pressure chart.									
acc. to ANSI			-20°F to 100°F	200°F	300°F	400°F	500°F	600°F	650°F	700°F	750°F	800°F
SA216WCB	ANSI150	(psi)	285	260	230	200	170	140	125	110	95	80
SA216WCB	ANSI300	(psi)	740	675	655	635	600	570	550	530	505	410
acc. to ANSI			-75°F to 100°F	200°F	300°F	400°F	500°F	600°F	650°F	700°F	750°F	800°F
SA351CF8M	ANSI150	(psi)	276	239	215	197	170	141	126	110	94	--
SA351CF8M	ANSI300	(psi)	719	624	560	515	479	453	442	435	426	--

Information / restriction of technical rules need to be observed!

Valves set under 15 psi are not ASME-Code stamped.

A production permission acc. to TRB 801 No. 45 is available.

The engineer, designing a system or a plant, is responsible for the selection of the correct valve.

Resistance and fitness must be verified (or contact the manufacturer for information).

NPS	1"x2"	1 1/2"x2"	1 1/2"x2 1/2"	1 1/2"x3"	2"x3"	3"x4"	4"x6"	4"x6"	6"x8"	6"x10"
-----	-------	-----------	---------------	-----------	-------	-------	-------	-------	-------	--------

Center-to-face dimensions acc. to API 526 (dedicated to API-Orifice)

Body size		D, E	F	G	H	J	L	M	P	Q	R
I	(in)	4 1/2	4 3/4	4 3/4	4 7/8	4 7/8	6 1/2	7 1/4	9	9 1/2	10 1/2
I1	(in)	4 1/8	4 7/8	4 7/8	5 1/8	5 3/8	6 1/8	7	7 1/8	9 7/16	9 7/16

Dimensions

d0	(in)	0.71 ¹⁾	0.89 ²⁾	1.14	1.14	1.42	1.77	2.30	3.54	3.54	4.17	4.92
A0	(in ²)	0.394 ¹⁾	0.617 ²⁾	1.024	1.024	1.578	2.465	4.166	9.861	9.861	13.678	19.022
H	(in)	11	13	13	15.4	17	21.5	27	27	33.3	35	
H (with stainless steel bellows)	(in)	13.2	15.4	15.4	17.5	19.7	24.4	31.8	31.8	36.2	37.5	
X	(in)	6	8	8	10	12	14	20		20	20	
C (Width of support tongues)	(in)	--	--	--	--	8.03	9.53	13.07		14.25	15.94	
Drainhole with plug	(in)	G1/4"						G3/8"				
	Optional, not standard											

¹⁾ for steam / gas at set pressure 15 to < 30 psig

²⁾ for steam / gas at set pressure 30 - 493 psig / Liquid at set pressure 15 - 493 psig

Weights

Standard	(lbs)	26	40	40	51	66	103	176	180	308	374
Option: stainless steel bellows	(lbs)	30	44	44	56	75	119	198	202	342	408

Standard-flange dimensions Flanges acc. to ASME / ANSI B16.5

ØD1	ANSI150	(in)	4.25	5	5	5	6	7.5	9	11	11
	ANSI300	(in)	4.88	6.12	6.12	6.12	6.5	8.25	10	12.5	12.5
ØD2	ANSI150	(in)	6	6	7	7.5	7.5	9	11	13.5	16
b1	ANSI150	(in)	0.69	0.81	0.81	0.81	0.88	1.12	1.25	1.44	1.44
	ANSI300	(in)	0.69	0.81	0.81	0.81	0.88	1.12	1.25	1.44	1.44
b2	ANSI150	(in)	0.75	0.75	0.88	0.94	0.94	0.94	1	1.12	1.19

Standard-Flangeholes

NPS		1"	1 1/2"	2"	2 1/2"	3"	4"	6"	8"	10"	
ØK	ANSI150	(in)	3.12	3.88	4.75	5.5	6	7.5	9.5	11.75	14.25
n x Ød		(in)	4 x 0.62	4 x 0.62	4 x 0.75	4 x 0.75	4 x 0.75	8 x 0.75	8 x 0.88	8 x 0.88	12 x 1
ØK	ANSI300	(in)	3.5	4.5	5.0	--	6.62	7.88	10.62	--	--
n x Ød		(in)	4 x 0.75	4 x 0.88	8 x 0.75	--	8 x 0.88	8 x 0.88	12 x 0.88	--	--

NPS	1"x2"	1 1/2"x2" 1 1/2"x2 1/2"	1 1/2"x3"	2"x3"	3"x4"	4"x6"	6"x8"	6"x10"
-----	-------	----------------------------	-----------	-------	-------	-------	-------	--------

Spring ranges: Standard design

Fig. 901/902/911/912	(psig)	15 - 22	15 - 22	15 - 22	15 - 22	15 - 22	15 - 22	15 - 16	15 - 22
	(psig)	> 22 - 29	> 22 - 29	> 22 - 29	> 22 - 29	> 22 - 29	> 22 - 29	> 16 - 22	> 22 - 27
	(psig)	> 30 - 39	> 30 - 39	> 30 - 39	> 30 - 39	> 30 - 39	> 30 - 39	> 22 - 27	> 27 - 33
	(psig)	> 39 - 53	> 39 - 53	> 39 - 53	> 39 - 53	> 39 - 53	> 36 - 44	> 27 - 36	> 33 - 39
	(psig)	> 53 - 73	> 53 - 73	> 53 - 73	> 53 - 73	> 53 - 73	> 44 - 53	> 36 - 43	> 39 - 48
	(psig)	> 73 - 131	> 73 - 131	> 73 - 131	> 73 - 131	> 73 - 131	> 53 - 73	> 43 - 58	> 48 - 59
	(psig)	> 131 - 232	> 131 - 232	> 131 - 232	> 131 - 232	> 131 - 232	> 73 - 131	> 58 - 83	> 47 - 80
	(psig)	> 232 - 319	> 232 - 319	> 232 - 319	> 232 - 319	> 232 - 319	> 131 - 203	> 83 - 119	> 80 - 107
	(psig)	> 319 - 406	> 319 - 406	> 319 - 406	> 319 - 406	> 319 - 406	> 203 - 276	> 119 - 174	> 107 - 160
	(psig)	> 406 - 493	> 406 - 493	> 406 - 493	> 406 - 493			> 174 - 246	> 160 - 232
	(psig)							> 246 - 348	> 232 - 305
	(psig)							> 348 - 392	

Spring ranges: Stainless steel bellows (optional)

Fig. 901/911	(psig)	36 - 48	36 - 46	38 - 53	41 - 49	36 - 54	36 - 51	16 - 22	15 - 19
	(psig)	> 48 - 67	> 46 - 58	> 53 - 66	> 49 - 66	> 54 - 67	> 51 - 61	> 22 - 28	> 19 - 25
	(psig)	> 67 - 79	> 58 - 80	> 66 - 81	> 66 - 122	> 67 - 86	> 61 - 72	> 28 - 35	> 25 - 31
	(psig)	> 79 - 102	> 80 - 93	> 81 - 108	> 122 - 145	> 86 - 116	> 72 - 81	> 35 - 42	> 31 - 35
	(psig)	> 102 - 131	> 93 - 115	> 108 - 145	> 145 - 167	> 116 - 145	> 81 - 102	> 42 - 51	> 35 - 41
	(psig)	> 131 - 170	> 115 - 167	> 145 - 181	> 167 - 232	> 145 - 261	> 102 - 116	> 51 - 61	> 41 - 45
	(psig)	> 170 - 232	> 167 - 268	> 181 - 232	> 232 - 268		> 116 - 135	> 61 - 74	> 45 - 50
	(psig)	> 232 - 319	> 268 - 363	> 232 - 319	> 268 - 334		> 135 - 167	> 74 - 94	> 50 - 57
	(psig)	> 319 - 435					> 167 - 189	> 94 - 109	> 57 - 70
	(psig)							> 109 - 131	> 70 - 84
	(psig)							> 131 - 153	> 84 - 99
	(psig)							> 153 - 183	> 99 - 118
	(psig)							> 183 - 247	> 118 - 141
	(psig)							> 247 - 363	> 141 - 164
	(psig)								> 164 - 189
	(psig)								> 189 - 218
(psig)								> 218 - 261	

Capacity saturated steam (incl. 10% overpressure)

NPS		1"x2" ²⁾	1 1/2"x2"	1 1/2"x2 1/2"	1 1/2"x3"	2"x3"	3"x4"	4"x6"	6"x8"	6"x10"	
Set pressure		Saturated steam (lb/hr)									
← max. set pressure stainless steel version	15 ¹⁾	(psig)	510	1326	1326	2044	3192	5395	12770	17713	24634
	20 ¹⁾	(psig)	588	1529	1529	2356	3680	6220	14723	20422	28401
	25 ¹⁾	(psig)	666	1732	1732	2668	4168	7045	16676	23140	32167
	29 ¹⁾	(psig)	729	1894	1894	2918	4559	7705	18238	25297	35181
	30	(psig)	1238	2055	2055	3167	4947	8361	19791	27452	38177
	35	(psig)	1381	2292	2292	3532	5518	9325	22073	30617	42579
	40	(psig)	1524	2529	2529	3897	6088	10289	24355	33782	46981
	45	(psig)	1667	2766	2766	4263	6659	11253	26637	36948	51383
	50	(psig)	1809	3003	3003	4628	7229	12217	28919	40113	55785
	55	(psig)	1952	3240	3240	4993	7799	13182	31201	43278	60187
	60	(psig)	2095	3477	3477	5358	8370	14146	33483	46444	64589
	65	(psig)	2238	3714	3714	5723	8940	15110	35765	49609	68991
	70	(psig)	2381	3951	3951	6088	9511	16074	38047	52774	73393
	75	(psig)	2523	4188	4188	6454	10081	17038	40329	55939	77795
	80	(psig)	2666	4425	4425	6819	10652	18002	42611	59105	82197
	85	(psig)	2809	4662	4662	7184	11222	18966	44893	62270	86599
	90	(psig)	2952	4899	4899	7549	11793	19930	47175	65435	91001
	95	(psig)	3095	5136	5136	7914	12363	20894	49457	68601	95403
	100	(psig)	3237	5373	5373	8279	12933	21858	51739	71766	99805
	125	(psig)	3951	6558	6558	10105	15786	26679	63149	87592	121815
160	(psig)	4951	8216	8216	12662	19779	33427	79123	109750	152629	
175	(psig)	5379	8927	8927	13757	21490	36319	85969	119245	165835	
200	(psig)	6093	10112	10112	15583	24342	41140	97379	135072	187845	
225	(psig)	6807	11297	11297	17409	27194	45960	108788	150898	209854	
250	(psig)	7521	12482	12482	19235	30047	50781	120198	166725	231864	
276	(psig)	8263	13714	13714	21134	33013	55794	132065	183184	254755	
300	(psig)	8949	14852	14852	22886	35751	60421		198378	275884	
325	(psig)	9663	16036	16036	24712	38603	65242		214204		
348	(psig)	10319	17126	17126	26392	41227	69676		228765		
375	(psig)	11090	18406	18406	28364	44308	74882		245857		
400	(psig)	11804	19591	19591	30190	47160	79703				
435	(psig)	12804	21250	21250	32746	51153					
450	(psig)	13232	21961	21961	33842	52864					
475	(psig)	13946	23145	23145	35667	55716					
493	(psig)	14460	23999	23999	36982	57770					

¹⁾ Capacity below 30 psig set pressure are calculated with 3 psig overpressure.

²⁾ NPS 1" x 2" set pressure 15 to < 30 psig: do = 0.709 in / set pressure ≥ 30 psig: do = 0.886 in

Capacity air (incl. 10% overpressure)

NPS		1"x2" ²⁾	1 1/2"x2"	1 1/2"x2 1/2"	1 1/2"x3"	2"x3"	3"x4"	4"x6"	6"x8"	6"x10"	
Set pressure		Air in SCFM (60°F; 14.7 psia)									
max. set pressure stainless steel version	15 ¹⁾	(psig)	182	472	472	727	1136	1920	4546	6305	8768
	20 ¹⁾	(psig)	209	544	544	839	1310	2214	5240	7269	10109
	25 ¹⁾	(psig)	237	616	616	950	1484	2508	5936	8233	11450
	29 ¹⁾	(psig)	259	674	674	1039	1623	2742	6492	9004	12522
	30	(psig)	441	732	732	1127	1761	2976	7044	9771	13589
	35	(psig)	492	816	816	1257	1964	3319	7857	10898	15156
	40	(psig)	542	900	900	1387	2167	3662	8669	12025	16723
	45	(psig)	593	985	985	1517	2370	4006	9481	13151	18289
	50	(psig)	644	1069	1069	1647	2573	4349	10293	14278	19856
	55	(psig)	695	1153	1153	1777	2776	4692	11106	15405	21423
	60	(psig)	746	1238	1238	1907	2979	5035	11918	16531	22990
	65	(psig)	797	1322	1322	2037	3182	5378	12730	17658	24557
	70	(psig)	847	1406	1406	2167	3385	5721	13542	18785	26124
	75	(psig)	898	1491	1491	2297	3588	6064	14355	19911	27690
	80	(psig)	949	1575	1575	2427	3791	6408	15167	21038	29257
	85	(psig)	1000	1659	1659	2557	3994	6751	15979	22165	30824
	90	(psig)	1051	1744	1744	2687	4197	7094	16792	23291	32391
	95	(psig)	1101	1828	1828	2817	4400	7437	17604	24418	33958
	100	(psig)	1152	1912	1912	2947	4604	7780	18416	25544	35525
	125	(psig)	1406	2334	2334	3597	5619	9496	22477	31178	43359
160	(psig)	1764	2927	2927	4511	7047	11909	28190	39101	54378	
175	(psig)	1915	3178	3178	4897	7649	12928	30600	42444	59027	
200	(psig)	2169	3599	3599	5547	8664	14643	34661	48078	66862	
225	(psig)	2423	4021	4021	6197	9680	16359	38722	53711	74696	
250	(psig)	2677	4443	4443	6846	10695	18075	42784	59344	82530	
276	(psig)	2944	4886	4886	7529	11762	19878	47052	65264	90763	
300	(psig)	3185	5286	5286	8146	12725	21506		70611	98199	
325	(psig)	3439	5708	5708	8796	13740	23222		76244		
348	(psig)	3677	6102	6102	9403	14688	24824		81503		
375	(psig)	3948	6551	6551	10096	15771	26654		87511		
400	(psig)	4202	6973	6973	10746	16786	28370				
435	(psig)	4562	7571	7571	11667	18225					
450	(psig)	4710	7817	7817	12046	18817					
475	(psig)	4964	8238	8238	12696	19832					
493	(psig)	5147	8542	8542	13163	20563					

¹⁾ Capacity below 30 psig set pressure are calculated with 3 psig overpressure.

²⁾ NPS 1" x 2" set pressure 15 to < 30 psig: do = 0.709 in / set pressure ≥ 30 psig: do = 0.886 in

Capacity water (incl. 10% overpressure)

NPS		1"x2"	1 1/2"x2"	1 1/2"x2 1/2"	1 1/2"x3"	2"x3"	3"x4"	4"x6"	6"x8"	6"x10"	
Set pressure		Water (gal/min)									
← max. set pressure stainless steel version	15 ¹⁾	(psig)	61	90	90	139	217	365	867	1202	1673
	20 ¹⁾	(psig)	69	102	102	157	245	414	979	1358	1889
	25 ¹⁾	(psig)	76	112	112	173	270	457	1081	1499	2085
	30	(psig)	83	122	122	188	293	496	1173	1627	2263
	35	(psig)	89	132	132	203	317	535	1267	1758	2444
	40	(psig)	96	141	141	217	339	572	1355	1879	2613
	45	(psig)	101	149	149	230	359	607	1437	1993	2772
	50	(psig)	107	157	157	242	379	640	1514	2101	2921
	55	(psig)	112	165	165	254	397	671	1588	2203	3064
	60	(psig)	117	172	172	265	415	701	1659	2301	3200
	65	(psig)	122	179	179	276	432	730	1727	2395	3331
	70	(psig)	126	186	186	287	448	757	1792	2486	3457
	75	(psig)	131	193	193	297	464	784	1855	2573	3578
	80	(psig)	135	199	199	307	479	809	1916	2657	3695
	85	(psig)	139	205	205	316	494	834	1975	2739	3809
	90	(psig)	143	211	211	325	508	858	2032	2818	3920
	95	(psig)	147	217	217	334	522	882	2088	2896	4027
	100	(psig)	151	222	222	343	535	905	2142	2971	4132
	125	(psig)	169	249	249	383	599	1012	2395	3322	4619
	160	(psig)	191	281	281	433	677	1144	2708	3756	5224
175	(psig)	200	294	294	453	708	1197	2833	3930	5466	
200	(psig)	214	315	315	485	757	1280	3029	4201	5843	
225	(psig)	227	334	334	514	803	1357	3213	4456	6197	
250	(psig)	239	352	352	542	847	1431	3387	4697	6533	
276	(psig)	251	369	369	569	889	1503	3557	4933	6861	
300	(psig)	262	385	385	594	927	1567		5146	7156	
325	(psig)	272	401	401	618	965	1631		5356		
348	(psig)	282	415	415	639	998	1687		5540		
375	(psig)	293	431	431	664	1037	1752		5753		
400	(psig)	302	445	445	685	1071	1810				
435	(psig)	315	464	464	715	1116					
450	(psig)	321	472	472	727	1136					
475	(psig)	329	485	485	747	1167					
493	(psig)	336	494	494	761	1189					

¹⁾ Capacity below 30 psig set pressure are calculated with 3 psig overpressure.

Approvals		
ARI-SAFE-SN ANSI	ASME Code Section VIII-Division 1 USA	
	Canada Registration - CRN	only construction with UV-stamp
	Pressure equipment directive PED 2014/68/EU Modul H1, B+D	

Soft sealing disc					
Pos.	Description	P min.	Material	Temperature range	Marking
12	Disc	15 psi	SA276 Gr.440 / EPDM	-40 °F to +302 °F	E
		15 psi	SA276 Gr.440 / FPM Viton (FKM)	-4 °F to +356 °F	V
		15 psi	SA276 Gr.440 / CR Neoprene	-22 °F to +212 °F	N
		15 psi	SA276 Gr.440 / SHR	-4 °F to +428 °F	S

EPDM-Bellows			
Pos.	Description	Material	Temperature range
43	EPDM-Bellows	EPDM 70 Shore A	14 °F to +248 °F

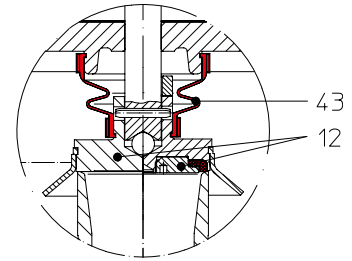

Back pressure compensating stainless steel-bellows (Only for closed version!)		
Pos.	Description	Material
55	Stainless steel bellows unit	SA240 / SA479 Gr.316 Ti
70	Balanced piston 1"x2" till 4"x6"	SA479 Gr.316 Ti

Test: German TA-Air TÜV-Test-No. 922-960324

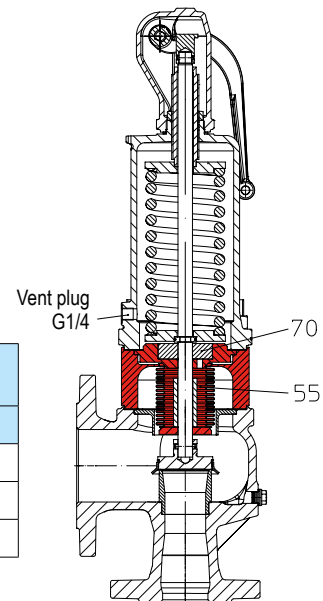

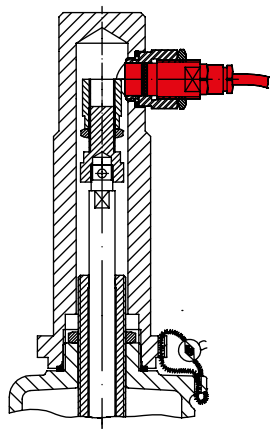

Proximity switch

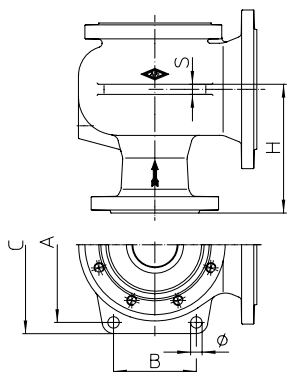

Support tongues, drilled

Body material	NPS	A	B	C	Ø	S	H
	(in)	(in)	(in)	(in)	(in)	(in)	(in)
SA216WCB	2" x 3"	6.93	2.76	8.03	0.55	0.47	5.63
	3" x 4"	8.35	3.54	9.53			6.38
	4" x 6"	11.61	6.50	13.07	0.71	0.63	7.32
	6" x 8"	12.52	7.21	14.25	0.87	0.79	9.76
	6" x 10"	14.17	7.87	15.94	0.87	0.87	9.88

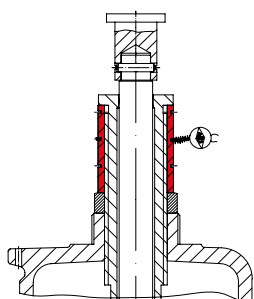

Lock bush

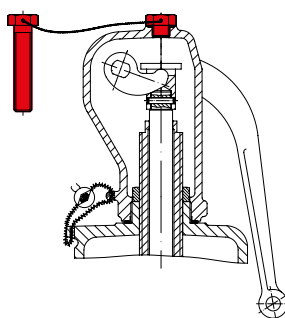

Test gag

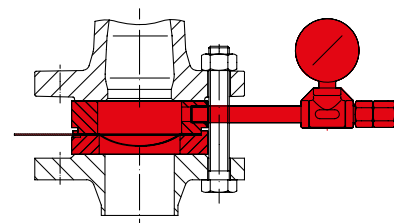

Rupture disc

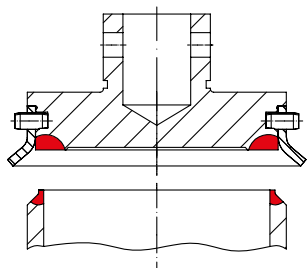

Seat SA479 Gr.316 Ti / Stellite No. 21
Disc SA479 Gr.316 Ti / Stellite No. 6
removable lifting aid

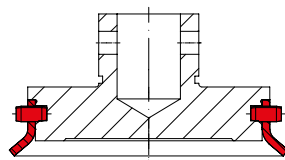

1"x2" - 4"x6"

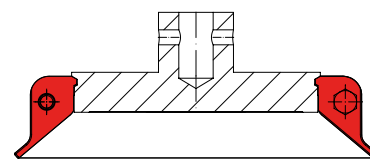

6"x8" - 6"x10"

removable lifting aid

myValve® - Your Valve Sizing-Program.

myValve® is a powerful software tool that not only helps you size your system components; it also gives you instant access to all other data about the selected product, such as order information, spare parts drawings, operating instructions, data sheets, etc., whenever you need it.



MyValve - Calculator

- Contents:**
- **Type-test approved acc. to ASME Code Section VIII-Division 1.**
 - **Module ARI-Safety valves SAFE-Semi Nozzle-Calculation**
 - Sizing (Calculation of valve-size with given capacity.)
 - Sizing acc. to ASME VIII, API520

- Media:**
- **Integrated media-databank (more than 160 media) with conditions:**
 - Vapours / gases
 - Steam (saturated and superheated)
 - Liquid

- Special features:**
- Project administration of the calculation and product data incl. spare part drawings concerning to project and tag number
 - Direct output or calculation and product data in PDF format
 - Product data could be taken for a direct order
 - SI- and ANSI-units with direct conversion to another databank
 - Settings with over pressure or absolute pressure
 - All ARI Pressure regulating valves are integrated in a databank
 - Direct access concerning to the product on data sheets, operating instructions, pressure-temperature-diagram and spare part drawings
 - Operation in company networks possible (no complex installations on individually PC's necessary)

- System Requirements:** Windows operating systems, Linux, etc.



Technology for the Future.
GERMAN QUALITY VALVES

ARI-Armaturen Albert Richter GmbH & Co. KG, D-33750 Schloß Holte-Stukenbrock,
Tel. +49 52 07 / 994-0, Telefax +49 52 07 / 994-158 or 159 Internet: <http://www.ari-armaturen.com> E-mail: info.vertrieb@ari-armaturen.com